

AGM-12-150

Valve-regulated lead-acid battery



GENERAL PURPOSE SERIES

Characteristics

Nominal voltage	12V (6 cells per unit)	
Nominal capacity at 10 hours rate/10.8V (25°C)	150Ah	
Capacity (25°C)	20 Hours rate/10.8V	159Ah
	5 Hours rate/10.8V	128Ah
Terminal type	T16	
Torque	12.3±2.5N.m	
Approx. internal resistance (25°C)	4.0mΩ	
Dimensions	Length	485±2mm (19.09inch)
	Width	172±2mm (6.77inch)
	Height	240±2mm (9.45inch)
	Total height (T14)	240±2mm (9.45inch)
Design Life (stand-by)	JIS at 25°C	10 years
	Eurobat at 20°C	10/12 years
Weight	41.50kg (92.10lbs)±3%	
Nominal operating temperature	25°C±3 (77±5°F)	
Operating temperature range	Discharge	-15°C~50°C (5°F~122°F)
	Charge	-10°C~50°C (14°F~122°F)
	Storage	-20°C~50°C (-4°F~122°F)
Float charging voltage at 25°C	13.5V~13.8V	
Cyclic charging voltage at 25°C	14.5V~15.0V	
Temperature compensation	Float charge	-18 mV/°C/Block
	Cycle charge	-30 mV/°C/Block
Max. charging current (A)	45A	
Max. discharge current for 5 seconds	1200A	
Self discharge rate (25°C)	≤3%/month	
Battery container ABS UL94-HB	V-0 optional	

Overview

General Purpose series batteries are de-signed with state-of-the-art AGM (absorbent glass mat) technology, high-performance plates and electrolyte. With excellent value and characteristics, this range is suitable for all general purpose applications.

Dimensions & Terminal Type (mm)

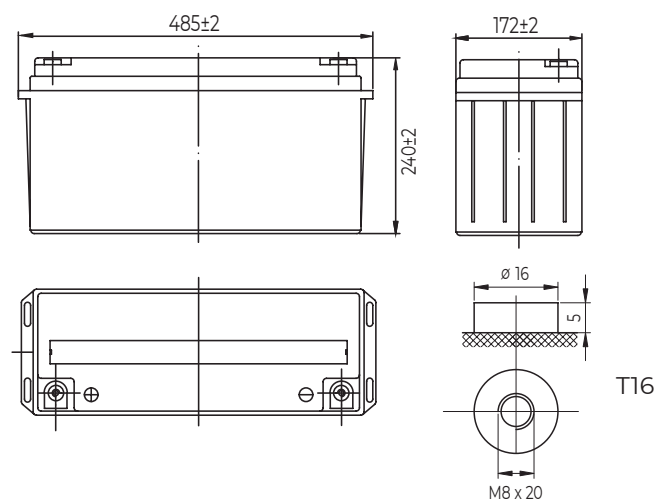

Construction

Component	Positive Plate	Negative plate	Container	Separator	Electrolyte	Safety valve	Terminal
Raw material	Lead dioxide	Lead	ABS (V-0 opt.)	AGM	Sulfuric Acid	Rubber	Copper

Constant current discharge characteristics at 25°C

(Ampere/battery)

F.V/Time	10min	15min	30min	60min	2h	3h	4h	5h	8h	10h	20h
9.60V	327	252	151	92.7	54.8	39.5	31.5	26.9	18.5	15.3	8.09
9.90V	317	246	148	91.3	54.5	39.2	31.3	26.8	18.4	15.2	8.08
10.2V	304	237	143	89.0	54.0	39.0	31.1	26.6	18.3	15.2	8.05
10.5V	291	229	140	86.2	53.2	38.7	30.9	26.4	18.2	15.1	8.01
10.8V	275	217	135	83.4	51.8	37.5	30.3	25.6	17.6	15.0	7.95

Constant power discharge characteristics at 25°C

(Watts/battery)

F.V/Time	10min	15min	30min	60min	2h	3h	4h	5h	8h	10h	20h
9.60V	3532	2767	1691	1057	635	464	371	318	220	182	97.1
9.90V	3426	2701	1658	1041	631	461	368	316	219	182	96.9
10.2V	3284	2601	1607	1015	625	458	366	314	217	181	96.6
10.5V	3143	2512	1568	983	616	455	363	312	216	180	96.1
10.8V	2967	2380	1510	951	600	441	352	303	209	179	95.4

The above characteristics represent average values and can be obtained within three charge and discharge cycles. The batteries must be fully charged before testing. The data in this document is subject to change without notice and become contractual only after written confirmation. Please contact Conexpro for the latest available version.

Discharge characteristics (25°C)

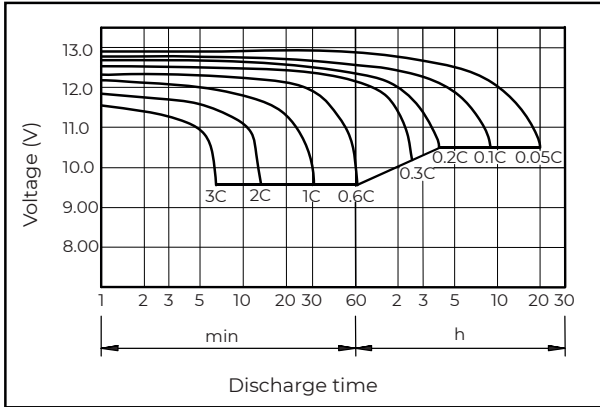

Charging characteristics (25°C)

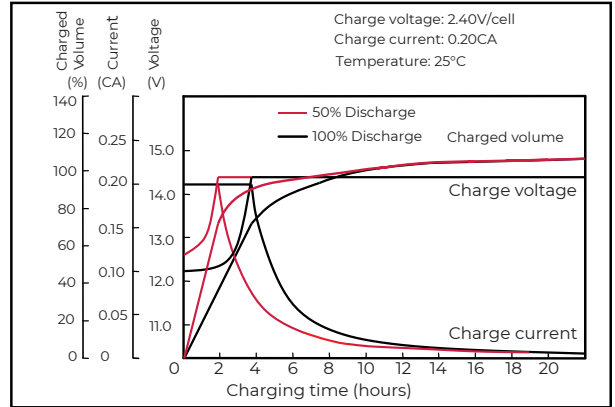

Temperature effects on capacity

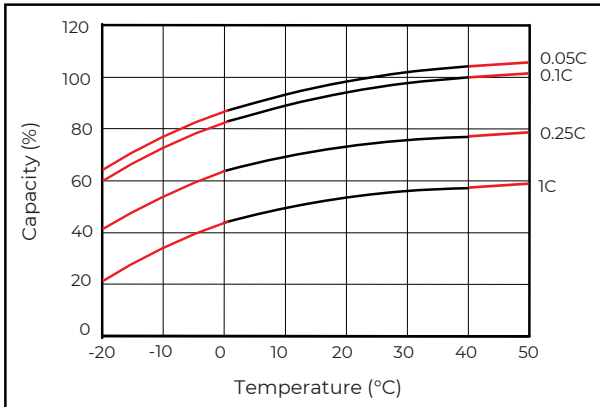

Self-discharge characteristics

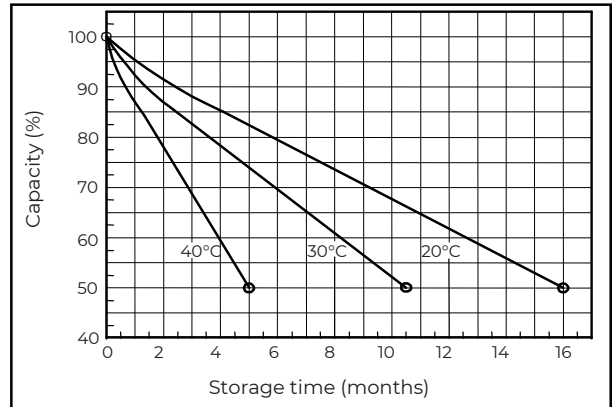

Floating life on temperature

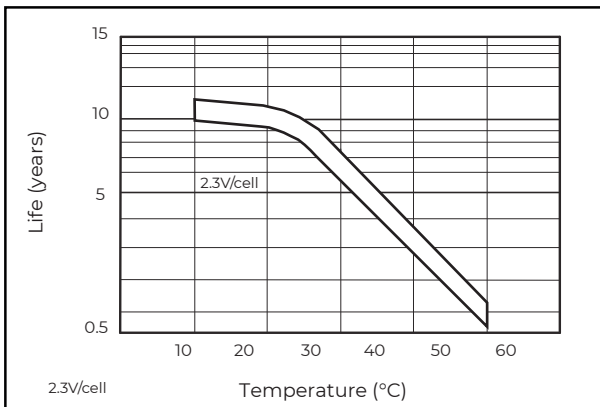

Cycle life on D.O.D (25°C)

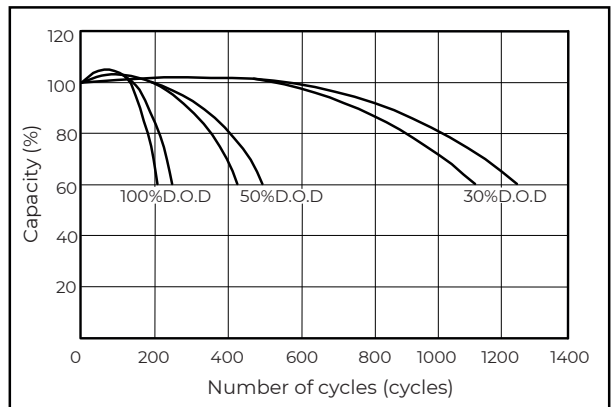

Relationship for OCV and capacity (25°C)

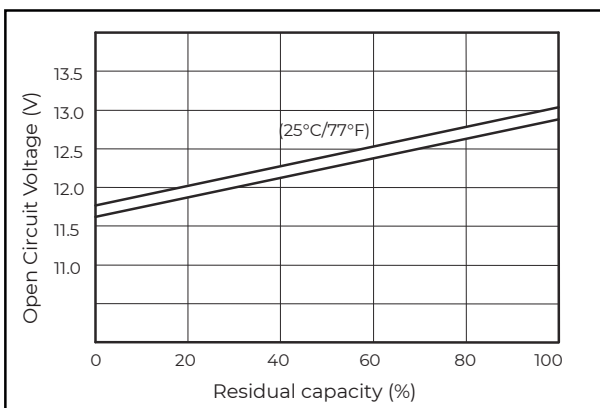

Charging voltage VS temperature

