



# GEL-12-40

Valve-regulated lead-acid battery



## GEL SERIES

### Characteristics

Nominal voltage	12V (6 cell per unit)	
Nominal capacity at 10 hours rate/10.8V (25°C)	40Ah	
Capacity (25°C)	20 Hours rate/10.8V	42.4Ah
	5 Hours rate/10.8V	33Ah
Terminal type	T14	
Torque	5.1±0.6N.m	
Approx. internal resistance (25°C)	8.5 mΩ	
Dimensions	Length	197±2mm (7.76inch)
	Width	165±2mm (6.50inch)
	Height	170±2mm (6.69inch)
	Total height	170±2mm (6.69inch)
Design Life (stand-by)	JIS at 25°C	12 years
	Eurobat at 20°C	10/12 years
Weight	13.50kg (29.80lbs)±3%	
Nominal operating temperature	25±3°C (77°F±5)	
Operating temperature range	Discharge	-15°C~50°C (5°F~122°F)
	Charge	-10°C~50°C (14°F~122°F)
	Storage	-20°C~50°C (-4°F~122°F)
Float charging voltage at 25°C	13.5V~13.8V	
Cyclic charging voltage at 25°C	14.5V~14.7V	
Temperature compensation	Float charge	-18 mV/°C/Block
	Cycle charge	-30 mV/°C/Block
Max. charging current (A)	8A	
Max. discharge current for 5 seconds	400A	
Self discharge rate (25°C)	≤3%/month	
Battery container ABS UL94-HB	V-0 optional	

### Overview

GEL Series are manufactured following the highest demands in the deep cycle and renew-able energy applications. The batteries use colloidal or foamed silica gel to immobilize the electrolyte, which further enhances the cycling stability. Available in top and front terminal types.

### Dimensions & Terminal Type (mm)

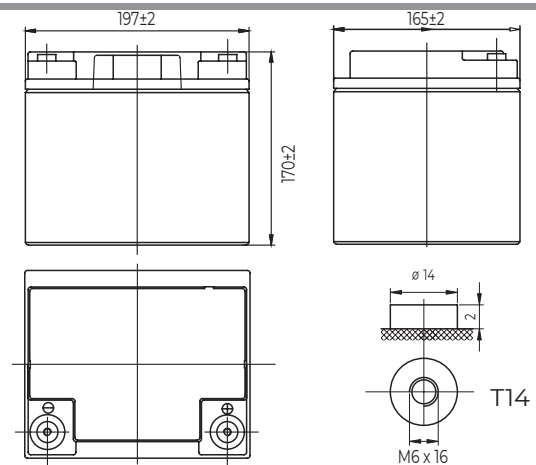

### Construction

Component	Positive Plate	Negative plate	Container	Separator	Electrolyte	Safety valve	Terminal
Raw material	Lead dioxide	Lead	ABS (V-0 opt.)	AGM	Sulfuric Acid Gel	Rubber	Copper

### Constant current discharge characteristics at 25°C

(Ampere/battery)

F.V/Time	10min	15min	30min	60min	2h	3h	4h	5h	8h	10h	20h
9.60V	78.0	64.0	38.8	24.0	14.6	10.4	8.16	6.94	4.90	4.07	2.16
9.90V	75.7	62.5	38.0	23.6	14.5	10.3	8.11	6.90	4.87	4.06	2.15
10.2V	72.5	60.2	36.9	23.0	14.4	10.3	8.06	6.85	4.83	4.05	2.15
10.5V	69.4	58.1	36.0	22.3	14.2	10.2	8.00	6.80	4.8	4.03	2.13
10.8V	65.5	55.0	34.6	21.6	13.8	10.0	7.76	6.60	4.66	4.00	2.12

### Constant power discharge characteristics at 25°C

(Watts/battery)

F.V/Time	10min	15min	30min	60min	2h	3h	4h	5h	8h	10h	20h
9.60V	842	703	435	274	169	122	96.0	82.0	58.2	48.6	25.9
9.90V	817	686	427	269	168	122	95.4	81.5	57.8	48.5	25.8
10.2V	783	661	414	263	167	121	94.7	80.9	57.4	48.4	25.8
10.5V	750	638	404	254	164	120	94.1	80.4	57.0	48.1	25.6
10.8V	708	604	389	246	160	118	91.3	78.0	55.3	47.8	25.4

The above characteristics represent average values and can be obtained within three charge and discharge cycles. The batteries must be fully charged before testing. The data in this document is subject to change without notice and become contractual only after written confirmation. Please contact **Conexpro** for the latest available version.

### Discharge characteristics (25°C)

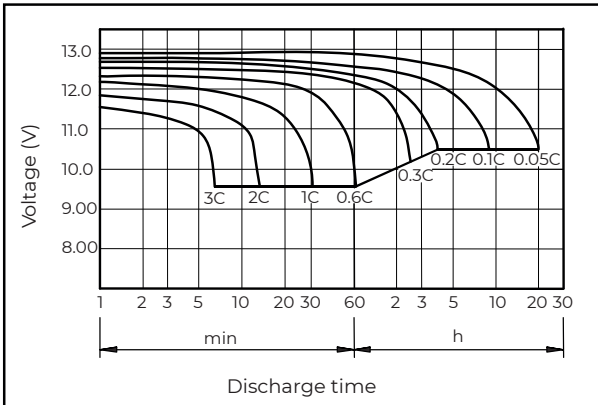

### Charging characteristics (25°C)

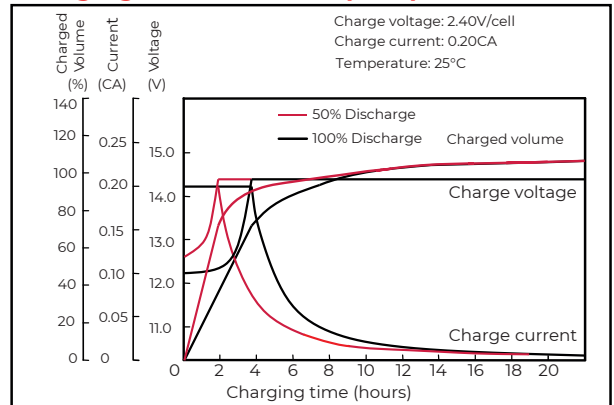

### Temperature effects on capacity

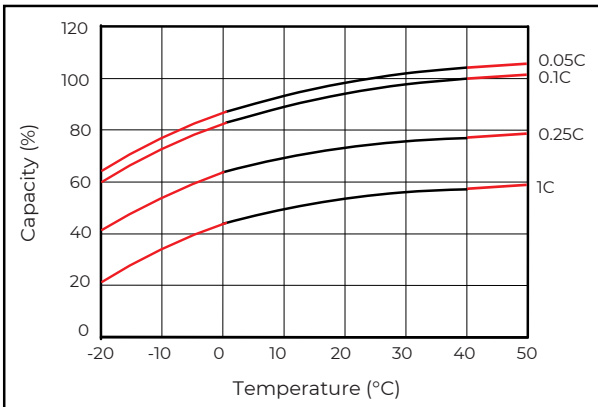

### Self-discharge characteristics

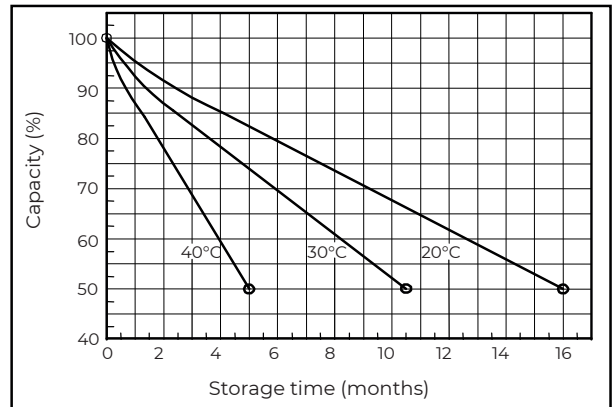

### Floating life on temperature

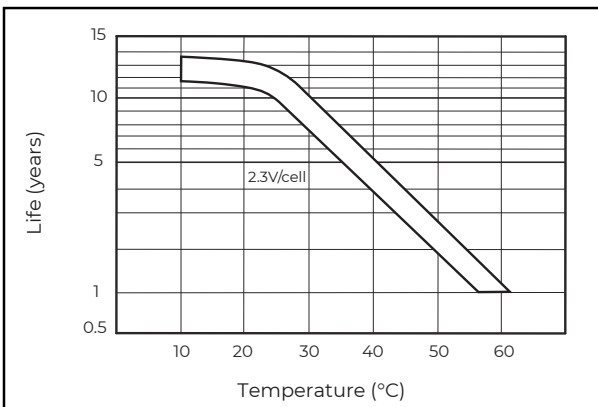

### Cycle life on D.O.D (25°C)

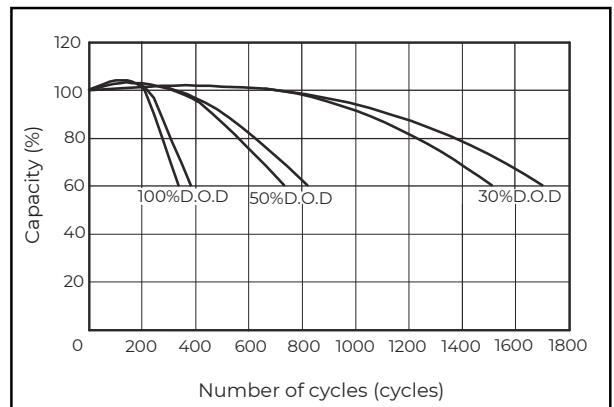

### Relationship for OCV and capacity (25°C)

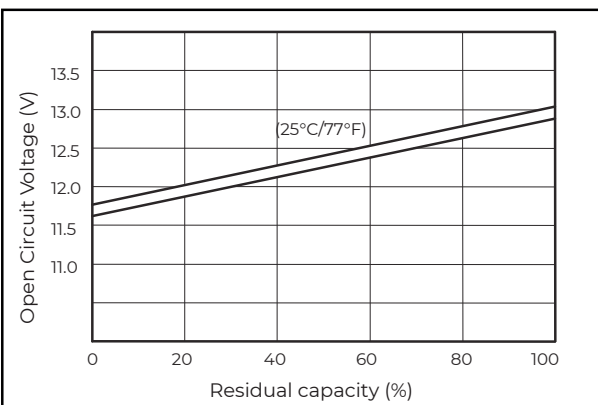

### Charging voltage VS temperature

