

LFP-12.8-50

Lithium iron phosphate battery



LITHIUM SERIES

Characteristics

Electrical		
Nominal voltage		12.8V
Nominal capacity at 5 hours rate (25°C)		50Ah
Energy		640Wh
Charge Efficiency at 0.2C (25°C)		99.5%
Discharge Efficiency at 1C (25°C)		96-99%
Approx. internal resistance (25°C)		≤16.0 mΩ
Cycle life / 0.2C 100% D.O.D		>3000 cycles
Capacity affected by temperature	40°C	101%
	25°C	100%
	0°C	90%
	-10°C	75%
Mechanical		
Dimensions	Length	197±2mm (7.76inch)
	Width	165±2mm (6.50inch)
	Height	170±2mm (6.69inch)
	Total height	170±2mm (6.69inch)
Terminal type		T14
Torque		5.1±0.6N.m
Weight		6.30kg (16.75lbs)±4%
Water & Dust resistance		IP65
Battery container ABS UL94-HB		V-0 optional
Cell strings		4 strings
Temperature		
Nominal operating temperature		25°C±3 (77±5°F)
Operating temperature range	Discharge	-20°C~60°C (-4°F~140°F)
	Charge	0°C~45°C (32°F~113°F)
	Storage	0°C~40°C (32°F~104°F)
Charging		
Charging voltage at 25°C		14.6V
Standard charge mode (25°C±2°C, <75%RH)		0.2CA Constant Current to 14.6V, then Constant Voltage 14.6V until the current drops to 0.02CA. Rest 30 minutes, before use.
Nominal charging current		10A
Maximum charging current		25A
Charging cut-off voltage		14.6V
Discharging		
Continuous discharge current		50A
Maximum pulse discharge current (<100ms)		150A
Discharge cut-off voltage		11.2V
Self discharge rate (25°C)		≤3%/month
Communication & connection		
Communication protocol (optional)		N/A
SOC (optional)		LED/Bluetooth
Maximum modules in paralel or series		1 string 1 paralel

Overview

Lithium-Iron Phosphate batteries offer superb improvement in characteristics compared to lead-acid technology. Due to the extreme cycle and calendar life, LiFePO₄ batteries are an excellent long-term investment for your applications. Powerful, lightweight, safe, and smart, the Lithium-Iron Phosphate batteries are the future of the energy storage you can have right now.

Features

Longer cycle life - Up to 15 times longer cycle life and 5 times longer float/calendar life than lead-acid batteries.

More capacity - Provides up to 100% of usable energy.

Lightweight - 60% lighter than lead-acid batteries.

High discharge rate - Ability to fully discharge the battery at a high rate of discharge.

Fast charging - Charges much faster than conventional sealed lead-acid batteries.

Long cycle life - More than 3000 cycles at 100% depth of discharge.

Intelligent BMS - The battery management system monitors and adapts to battery conditions to maximize performance and safety.

Dimensions & Terminal Type (mm)

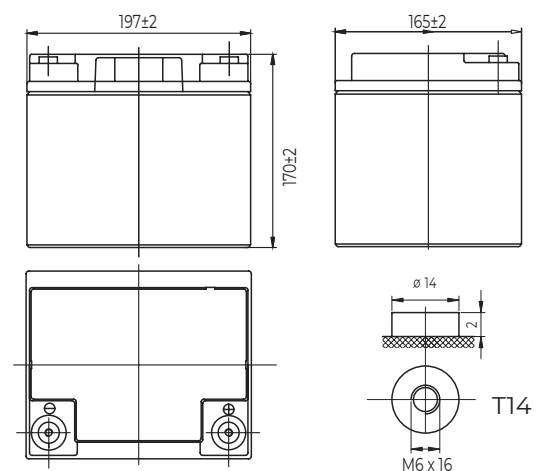

LFP-12.8-50

Lithium iron phosphate battery

LITHIUM

SERIES

Discharge characteristics (25°C)

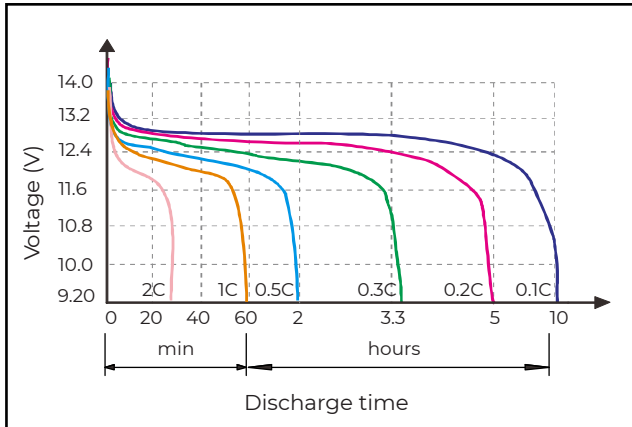

Temperature effects on discharge (0.5C)

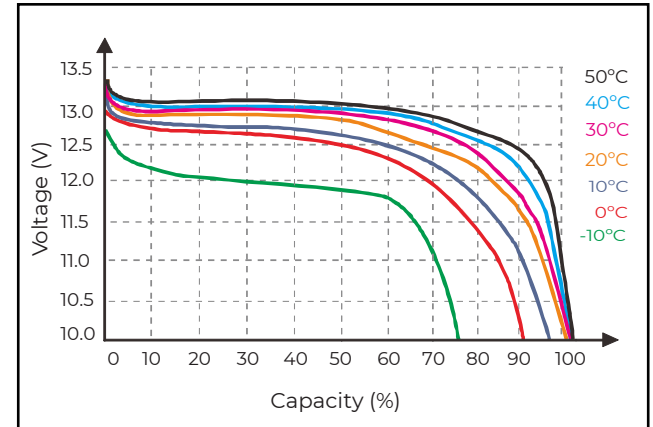

Charging Time on S.O.C. (25°C)

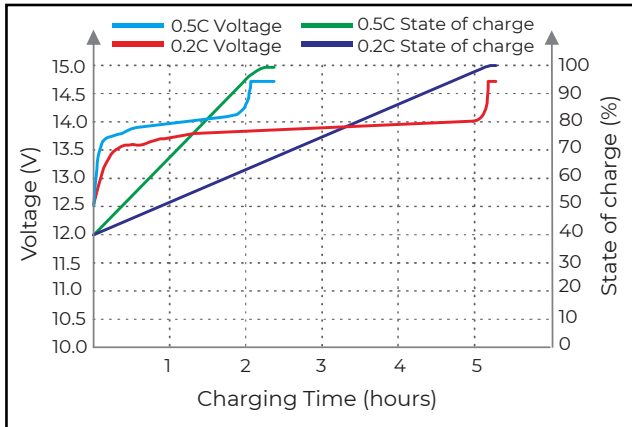

Charge characteristics (25°C)

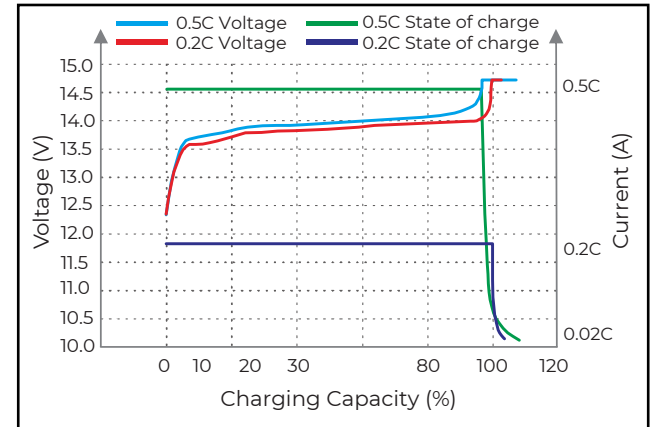

Cycle life on D.O.D. (25°C)

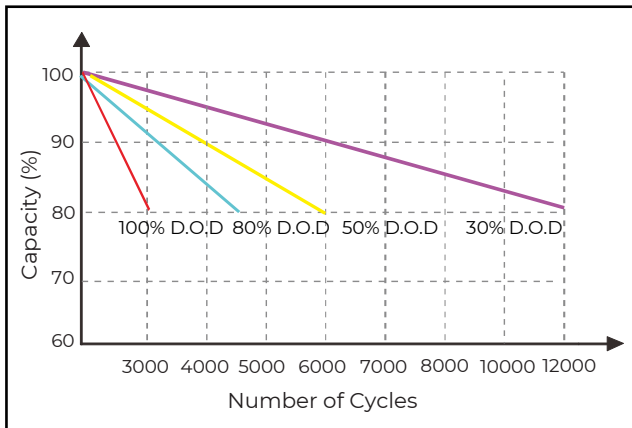

Self discharge characteristics

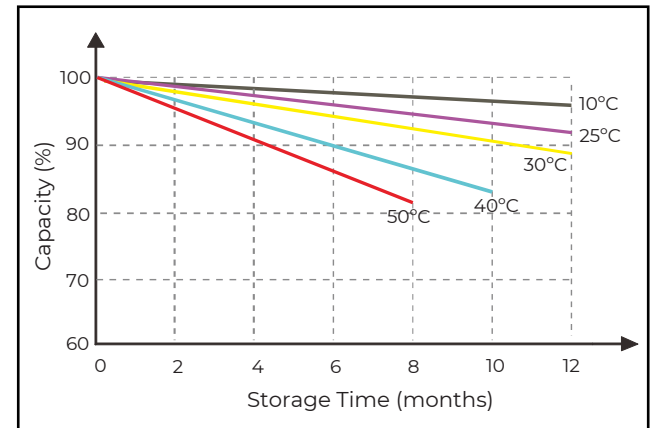

D.O.D. - depth of discharge
S.O.C. - state of charge