

5 GHz 90° 4x4 Asymmetrical Horn Antenna

HIGH PERFORMANCE 4x4 HORN ANTENNA

This 5 GHz 4x4 Asymmetrical Beam antenna is designed for excellent performance with MU-MIMO radios, such as ePMP 3000 or ePMP 4500. 4x4 Antenna Array is based on Award Winning 90° Asymmetrical Horn Antenna elements. Overall radiation pattern is 90° wide in the azimuth plane and 25° in elevation.

Outstanding noise rejection and precision of the radiation pattern throughout the bandwidth of operation favor the antenna for high-density access point clusters and densely co-located sites. Antenna features RP-SMA female connectors and integrated mount of ePMP 3000 4x4 radio.

Asymmetrical Horn antennas were awarded WISPA Product of the Year 2019, 2020 and 2021 Awards.



TECHNICAL DATA

Radio Connection	4x RP-SMA Female Connector
Pigtails	4x RP-SMA Male Connector 750mm (29.5 inch)
Antenna Type	Horn
Materials	UV Resistant ABS Plastic, Polycarbonate, HDPE, Aluminium, Stainless Steel
Environmental	IP55
Pole Mounting Diameter	40-80 mm (1.5-3.1 inch) Recommended as close to 80 mm (3.1 inch) as possible, recommended mounting on stand off bracket
Temperature	-35°C to +60°C (-31°F to +140°F)
Wind Survival	160 km/h (100 mi/h)
Wind Load	173/93 N - Front/Side at 160 km/h (100 mi/h)
Effective Projected Area	1309/754 cm ² - Front/Side (202.9/116.9 in ²)
Mechanical Adjustment	± 20° Elevation
Weight	10.6 kg (23.3 lbs) – single unit* 14 kg (30.8 lbs) – single unit incl. package*
Single Unit	Retail Box: 485 x 420 x 396 mm (19 x 16.5 x 15.5 inch)*

PERFORMANCE

Frequency Range	5180 - 6000 MHz
Gain	16 dBi
Azimuth Beam Width -3 dB	H 60° / V 60°
Elevation Beam Width -3 dB	H 16° / V 16°
Azimuth Beam Width -6 dB	H 90° / V 90°
Elevation Beam Width -6 dB	H 25° / V 25°
Beam Efficiency	90 %**
Front-to-Back Ratio	30 dB
VSWR Typical	1.5
Polarization	Dual Linear H + V
Impedance	50 OHm

*Subject to change, **Main beam defined up to first null



This product was produced under the conditions of a certified management system that meets the requirements of the ISO 9001, ISO 14001 and ISO 45001 standard, while this system was certified by QSCert.

SINGLE CHANNEL AZIMUTH PATTERN

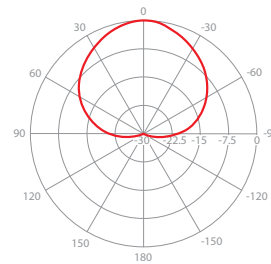

V/H - Port Pattern Azimuth 5.6 GHz

SINGLE CHANNEL ELEVATION PATTERN

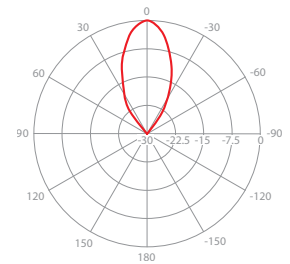

V/H - Port Pattern Elevation 5.6 GHz

GAIN

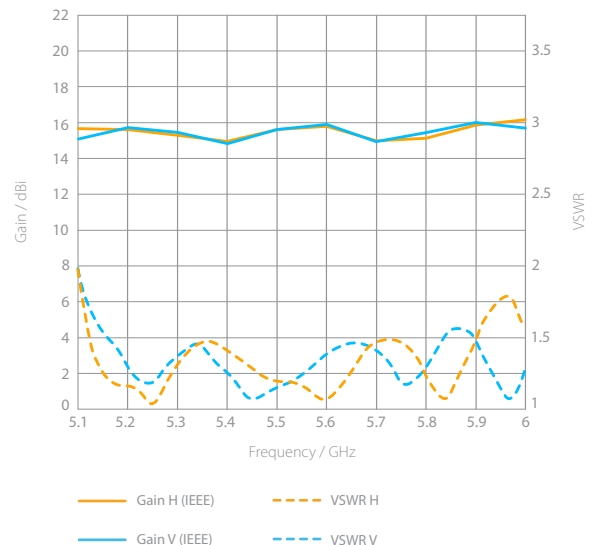

Product Datasheet

Product ID: AH90-4x4-SMA



PRODUCT DIMENSIONS

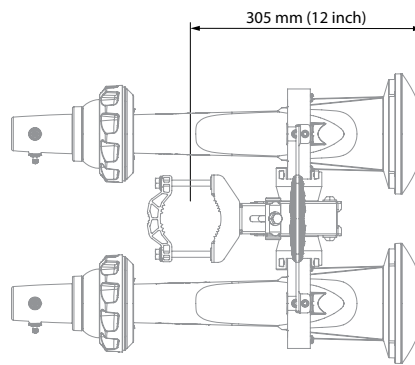
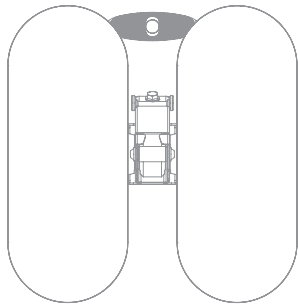
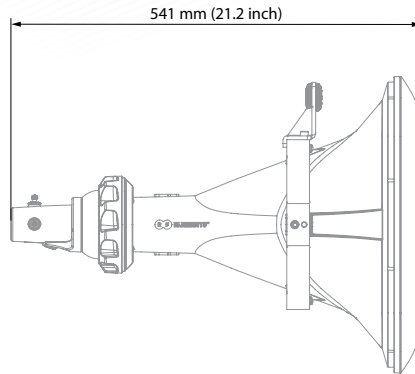
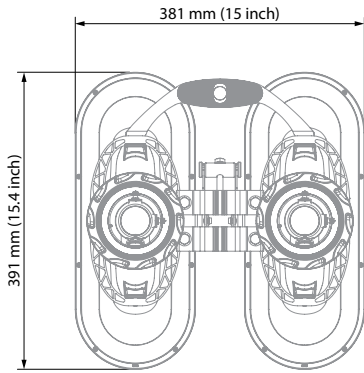

Product dimensions with Cambium ePMP 3000
Radio sold separately

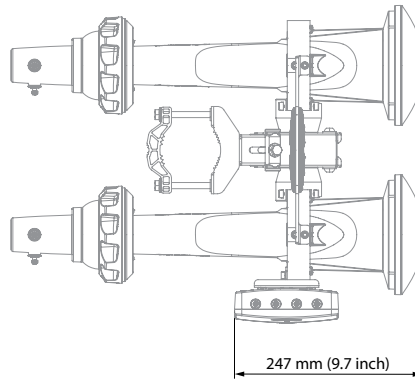
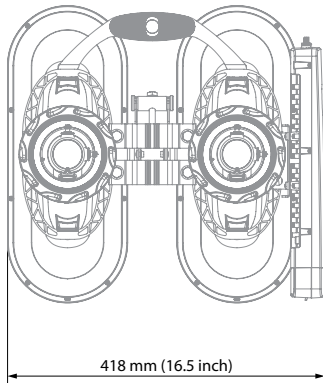

Product dimensions with Mimosa A5c
Radio sold separately

